

Data Sheet

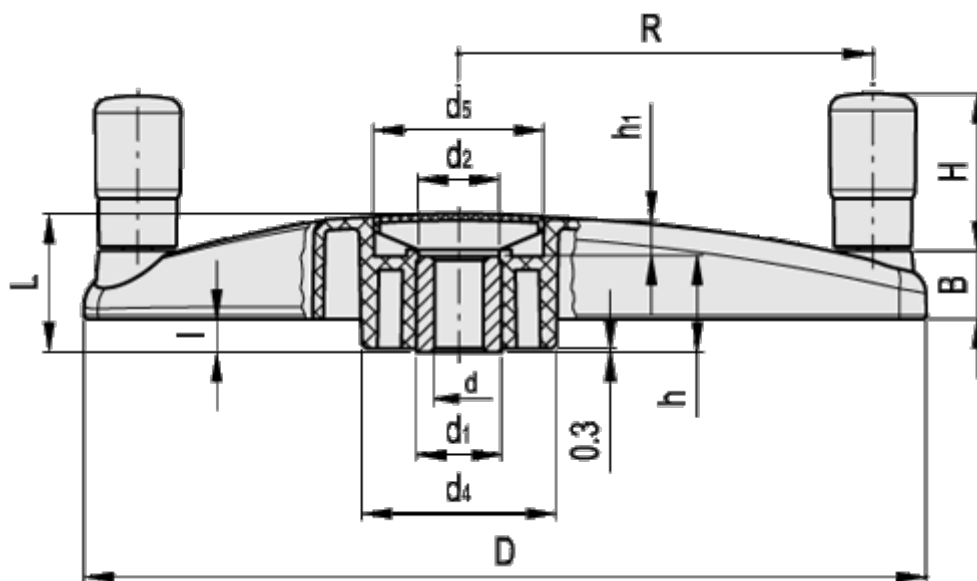

Article number: 23102077316
Description: E+G Handwheel
ETK.400+I A-20-C6

Measures



B = 28	h = 38
d = 400	h1 = 14
d1 = 35	l = 12
d2 = 33	L = 54
d4 = 80	R = 178
d5 = 70	
d h7 = 20	
H = 65	